

BASICS

A few simple tools are required:

- Measuring tape
- Power drill, drill bits
- Hex head and/or Phillips driver bit
- Pencil

Additional fasteners other than those sent with your shade may be required depending on the mounting surface. Wallboard and plaster require the use of anchors such as expansion or toggle bolts. Brick, tile or stone need special plugs and drill bits. Remember to always pre-drill holes in wood to avoid splitting.

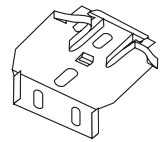

Standard and Top-Down Bottom Up Installation Bracket

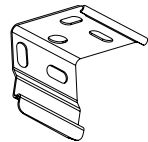

Continuous Loop Installation Bracket

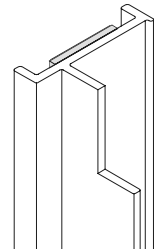

Side Track Rail with Magnet



Magnet with Foam Tape

MOUNT THE SHADE

The minimum required depth for installation is 1-1/2". The minimum depth required for Flush mount installation is 2".

BRACKET INSTALLATION

Shades are shipped with the required number of brackets for proper installation. End brackets should be located with centerlines 2-1/2" in from each end. Depending on the width of the shade, additional brackets may be necessary evenly spaced between the two end brackets.

For shade widths of:	Use this Number of brackets:
Up to 40"	2
40" - 72"	3
72" - 84"	4
84" and up	5

Standard Brackets

The brackets are mounted flat against the top sill surface.

The minimum depth required is 1-1/2".

To fully recess the shade requires a flat surface with a minimum depth of 2".

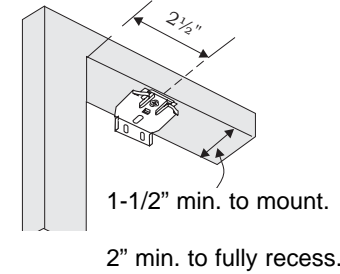

Continuous Loop Brackets

The brackets are mounted flat against the top sill surface.

The minimum depth required is 1-1/2".

To fully recess the shade requires a flat surface with a minimum depth of 2".

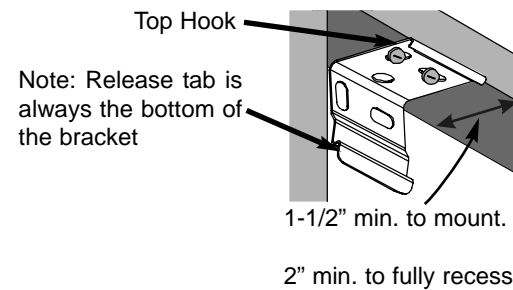

SHADE INSTALLATION

Standard and Continuous Loop

Unwind the cord from the shade. Bring the top rail up near the installation brackets. Center the shade in the window opening and attach the headrail to the installation brackets.

Standard Brackets

Insert the front clip of the installation bracket into the front groove of the rail.

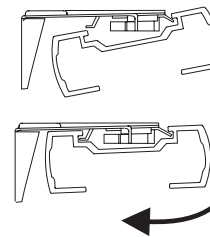

Push the rail back and up until the back clips of the bracket are inserted in the back groove of the rail.

Continuous Loop Brackets

Position the headrail with the front lip (A) resting on the top hooks of all brackets. Make sure no fabric is pinched between the bracket and headrail.

Push the bottom of the headrail firmly upwards and toward the window until the groove at the bottom of the headrail snaps into place, (B) as shown.

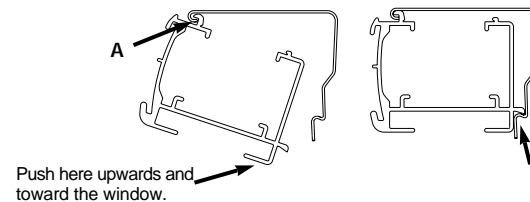

TRACK MOUNTING

Mount the shade.

NOTE: DO NOT REMOVE THE RELEASE LINER FROM THE MAGNETS YET.

Place the top end of the track into the slotted end caps and carefully slide up into place (Fig 1).

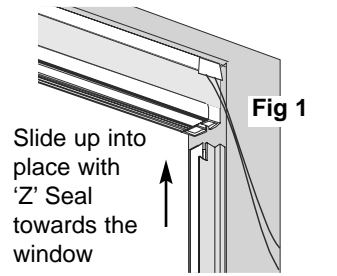

While holding the track in place, measure the distance from the front of the track to the edge of the window frame at the top.

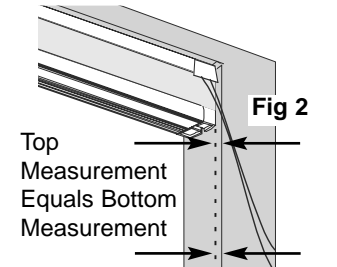

Mark the bottom of the window at the same point as the top measurement (Fig 2). Repeat for other side.

Remove the shade. Peel the release liner back from the magnet.

Carefully line the front edge of the track up to the top and bottom marks without letting the tape touch the window frame (Fig 3).

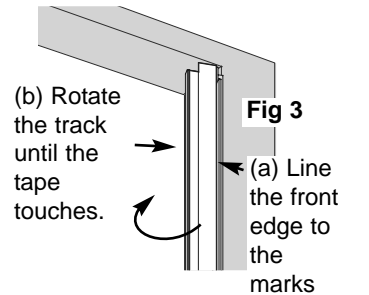

When correctly lined up, press the tape against the frame. Push firmly from top to bottom to ensure a good adhesion (Fig 4).

Repeat for the other track.

Pull the tracks off the magnets and reinstall the shade.

Carefully slide the top of the track into the notch in the shade and push up.

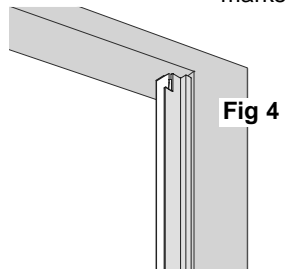

Let the track snap onto the magnet. Repeat for the other side.

OPERATION

Standard Shades

To lower or release shade, pull the cord inward toward the center of the shade. To raise or lock the shade, pull the cord straight down and outward toward the edge of the shade.

Top-Down Bottom Up

One cord will raise or lower the bottom rail, the other cord will raise or lower the top. Pull the cord inward toward the center of the shade to lower or release shade. Pull the cord straight down and outward toward the edge of the shade to raise or lock the shade.

Continuous Loop Shades

Operate the shade by pulling down on one side of the cord. One side of the cord raises the shade, the other side lowers the shade. Do not lift the bottom rail with your hands. Also, be careful not to place objects on the window sill that will interfere with operating the shade or cause it to hang unevenly. If the shade does become crooked, simply lower it as far as it will go and then raise it again. This will ensure that all the lift lines inside the shade are pulling up evenly.

BREAKTHROUGH CORD CONNECTOR

The breakthrough cord connector applies to Standard and Top-Down Bottom-Up shades. *Omni-Rise shades do not have a Breakthrough Cord Connector.*



WARNING

To avoid entanglement and strangulation, keep cords out of the reach of young children. Move cribs and furniture away from blind cords.

To further reduce hazards, this shade was built with a cord connector which was designed to break apart when force is applied from the top.

No safety system is fail-safe. KEEP CORDS OUT OF REACH OF SMALL CHILDREN!

If your cord connector should happen to break apart, follow the instructions below to reassemble.

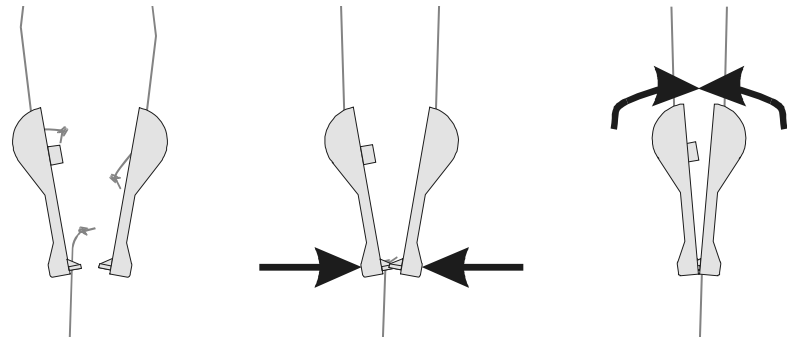
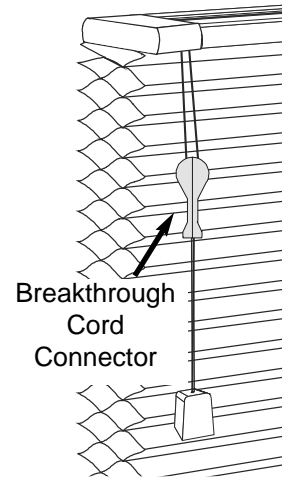

When the connector is open, each side has a cord coming in at the top, one side has a cord coming in from the bottom.

Fit the bottom edges together. The side with the cord fits into the side without the cord.

Swing the top ends together and press in the middle to fully connect.

EZEQ - Equalization

Cellular shades use a system that allows easy leveling of the bottom rail.

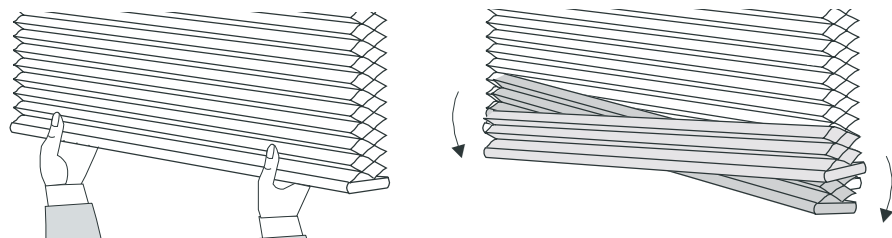

Stand in the center of the shade and grasp the bottom rail with both hands. Give the bottom rail a slight tug. This will fully engage the cord-lock.

Position the rail as desired, by pulling down on the side that is too high.

PROTECT YOUR CHILDREN

Be aware that it is possible for children to strangle in window covering cords. To reduce the occurrence of accident, all cords must be kept out of the reach of children, including infants. Cord cleats and Tensioner devices are an effective way to implement this essential precaution.

Standard and Top-Down Bottom-Up

Mount the cord cleat at a safe height, taking into account furniture or other objects upon which a child may climb. Then, after each use of the shade, simply wrap the excess cord around the cleat. It's fast, easy and safe.



Continuous Loop Shades

The Tension Device reduces the hazards of strangulation and entanglement of young children by limiting access to the control cord. Anchor the Tension Device that is attached to the blind's control cord to the window frame or wall, so that young children cannot pull the cord around their necks.

- Hold the Tension Device upright and position the Tension Device using one of the three methods shown.
- Position the Tension Device so that the Tension Device and the control cord do not interfere with raising or lowering the blind.

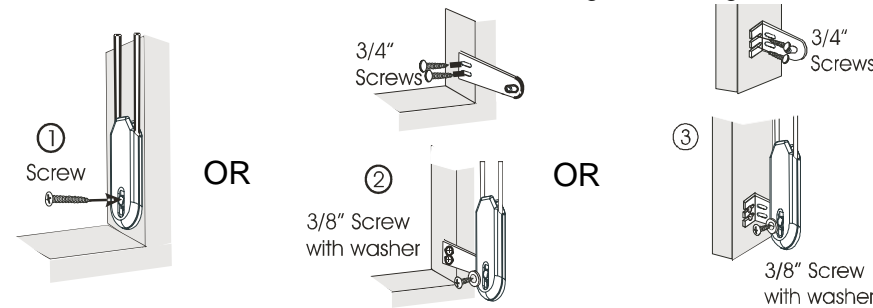

The Tension Device should be installed without stretching or pulling down on the control cord. Stretching the cord will cause excessive wear. Do not twist or cross the control cord.

TROUBLE SHOOTING

Problem: Shade is difficult to operate, especially near the top.

Cause: Brackets and Side Track may not be properly aligned.

Repair: Adjust brackets as necessary so the track is centered in the bottom rail end cap.

CLEANING AND CARE

The Shade fabric is easy to care for. Regular dusting with a feather duster or vacuum cleaner brush is recommended. Most stains can be blotted with a damp sponge and mild detergent. For problem stains, the shade can be removed from the Installation brackets and soaked in warm water. When damp, raise shade tightly to re-crisp pleats.

Due to the superior insulation properties of this window treatment, it is sometimes possible for condensation to build up between the window and the shade. This happens most frequently when the window is old or not sealed properly. If condensation does occur, simply let your window breathe by occasionally raising the shade.

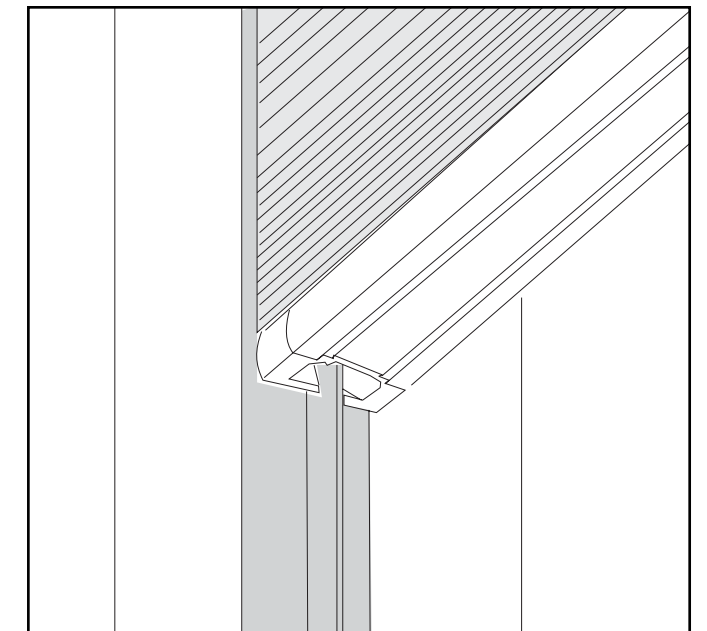

Side Track

Energy Saving Shade System

Installation Instructions

Our window fashions represent a design breakthrough in style, efficiency and function. Our Cellular shades feature 100% non-woven polyester fabric providing a soft diffused light and high level of privacy. The unique hardware system is designed to provide years of reliable service when properly installed.

Please take a few minutes to read through these instructions before beginning.