

SmartRise™ Honeycomb Shades

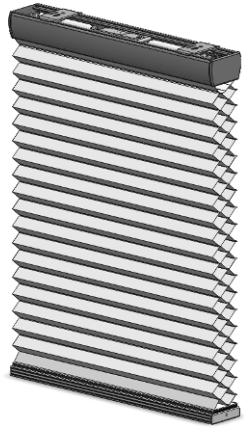

Getting Started





Remove shade from package. Save packaging until shade is installed and working to your satisfaction.

Tools:

- Level
- Measuring Tape
- Pencil
- Power drill (1/4" hex driver and drill bit)
- Screwdriver



Fasteners for different mounting surface:

Surface	Fastener
Wood	#8 1 1/4" Screws (Provided) 
	#6 3/4" screw 
Drywall/Plaster	Wall Anchors, Expansion Bolts (Not Provided) 
Metal	Sheet Metal Screws (Not Provided) 

Step 1: Bracket Installation

- Measure 3" from both ends of the head rail. Mark the bracket location on the mounting surface

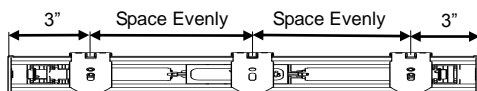

Inside Mount

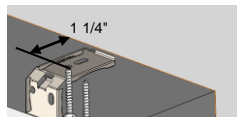

- Use level to align the brackets. For flush mount, allocate 1 1/4" from wall to the center of Screws.

- Use #8 1 1/4" mounting screws to secure brackets. Use wall anchors for drywall or plaster wall.

Outside Mount

- Use level to align the brackets. Allocate a minimum distance of 1 1/8" from wall to the center of screw.

Use mounting screws to secure each bracket. Use wall anchors for drywall or plaster wall.

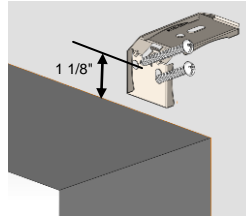

Step 2: Shade Installation

- Position head rail at an angle so that it is hooked to the front of the bracket. Then push it upward to snap into the bracket.

⚠️ For proper installation, attach the front rail to the bracket.

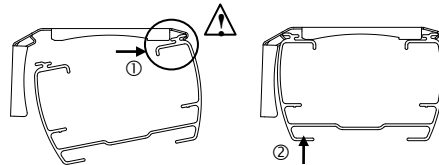

Step 3: Shade Operation

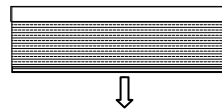

To lower the shade, gently pull the bottom rail down and stop at the desired height.

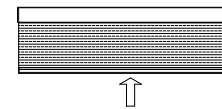

To raise the shade, gently raise the shade to desired height.

How to Install Hold-Down Brackets (optional)

- Use #6 3/4" screw to secure each bracket.

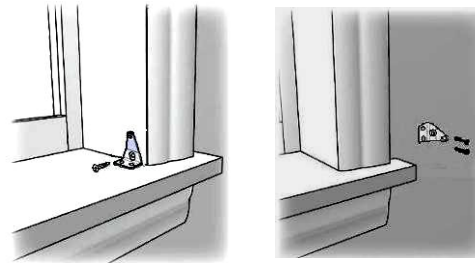

Remove the Shade

- Fully raise the shade.
- Gently pry the bracket off the head rail with a flat screwdriver.
- Remove the shade.

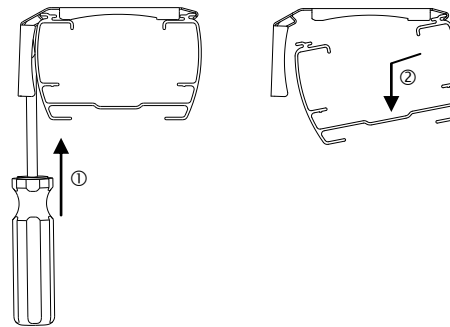

How to Install & Remove Shade Handle (optional)

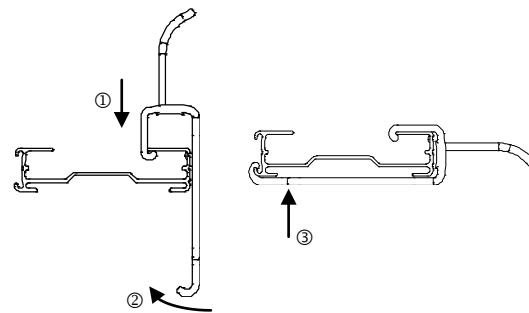

To install the handle, place handle to bottom rail. Flip over and snap into the groove of the rail.

To remove handle, hold the bottom rail, detach handle from rail and flip over.

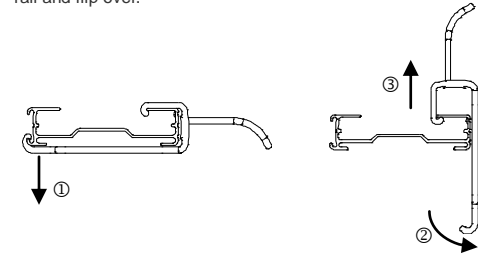

Cleaning the Shade

Routine cleaning will help maintain the beauty of your shades. To care for your shades use any of the following options:

- **Dusting**
Regularly dust the shade with a duster. In most situations this is the only cleaning method needed.
- **Vacuuming**
Use a hand-held vacuum on low suction setting to remove dust.
- **Spot-Cleaning**
Dampen a clean cloth with warm water and mild detergent solution and then dab the spot until stain is gone. Do not rub! Allow the fabric to dry in a fully lowered shade position.

Troubleshooting

Problem	Solution
The shade will not snap into the mounting brackets	Check if mounting brackets are aligned. Refer to Step 1.
The shade will not lift	Gently pull down on the bottom rail to reactivate the cordless mechanism. Repeat if necessary.

